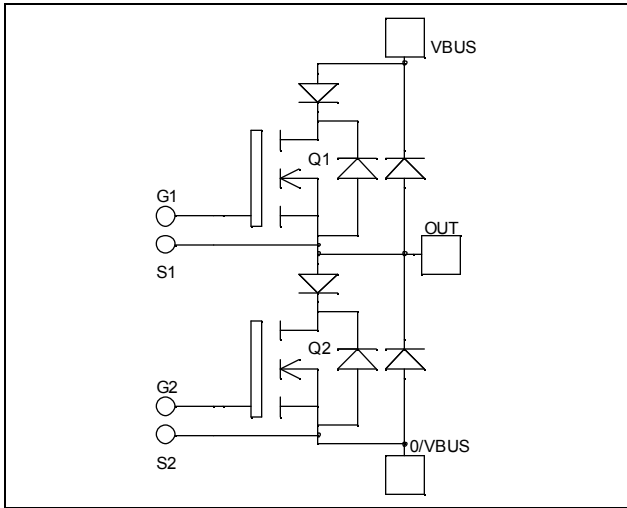

*Phase leg  
Series & parallel diodes  
MOSFET Power Module*

**$V_{DSS} = 1200V$**   
 **$R_{DSon} = 200m\Omega$  typ @  $T_j = 25^\circ C$**   
 **$I_D = 50A$  @  $T_c = 25^\circ C$**

**Application**

- Motor control
- Switched Mode Power Supplies
- Uninterruptible Power Supplies

**Features**

- Power MOS 7<sup>®</sup> MOSFETs
  - Low  $R_{DSon}$
  - Low input and Miller capacitance
  - Low gate charge
  - Fast intrinsic reverse diode
  - Avalanche energy rated
  - Very rugged
- Kelvin source for easy drive
- Very low stray inductance
  - Symmetrical design
  - M5 power connectors
- High level of integration

**Benefits**

- Outstanding performance at high frequency operation
- Direct mounting to heatsink (isolated package)
- Low junction to case thermal resistance
- Low profile
- RoHS Compliant

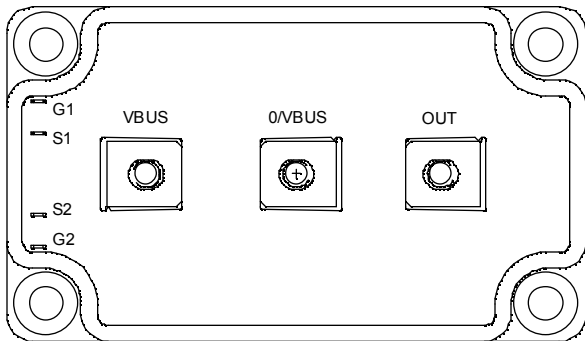
**Absolute maximum ratings**

Symbol	Parameter	Max ratings	Unit
$V_{DSS}$	Drain - Source Breakdown Voltage	1200	V
$I_D$	Continuous Drain Current	$T_c = 25^\circ C$	50
		$T_c = 80^\circ C$	37
$I_{DM}$	Pulsed Drain current	200	A
$V_{GS}$	Gate - Source Voltage	$\pm 30$	V
$R_{DSon}$	Drain - Source ON Resistance	240	m $\Omega$
$P_D$	Maximum Power Dissipation	$T_c = 25^\circ C$	1250
$I_{AR}$	Avalanche current (repetitive and non repetitive)	12	A
$E_{AR}$	Repetitive Avalanche Energy	30	mJ
$E_{AS}$	Single Pulse Avalanche Energy	1300	

**CAUTION:** These Devices are sensitive to Electrostatic Discharge. Proper Handling Procedures Should Be Followed. See application note APT0502 on [www.microsemi.com](http://www.microsemi.com)

All ratings @  $T_j = 25^\circ\text{C}$  unless otherwise specified

**Electrical Characteristics**

Symbol	Characteristic	Test Conditions	Min	Typ	Max	Unit
$I_{DSS}$	Zero Gate Voltage Drain Current	$V_{GS} = 0\text{V}, V_{DS} = 1200\text{V}$			1.5	mA
		$V_{GS} = 0\text{V}, V_{DS} = 1000\text{V}$			6	
$R_{DS(on)}$	Drain – Source on Resistance	$V_{GS} = 10\text{V}, I_D = 25\text{A}$		200	240	m $\Omega$
$V_{GS(th)}$	Gate Threshold Voltage	$V_{GS} = V_{DS}, I_D = 6\text{mA}$	3		5	V
$I_{GSS}$	Gate – Source Leakage Current	$V_{GS} = \pm 30\text{V}, V_{DS} = 0\text{V}$			$\pm 450$	nA

**Dynamic Characteristics**

Symbol	Characteristic	Test Conditions	Min	Typ	Max	Unit
$C_{iss}$	Input Capacitance	$V_{GS} = 0\text{V}$		15.2		nF
$C_{oss}$	Output Capacitance	$V_{DS} = 25\text{V}$		2.2		
$C_{rss}$	Reverse Transfer Capacitance	$f = 1\text{MHz}$		0.42		
$Q_g$	Total gate Charge	$V_{GS} = 10\text{V}$		600		nC
$Q_{gs}$	Gate – Source Charge	$V_{Bus} = 600\text{V}$		84		
$Q_{gd}$	Gate – Drain Charge	$I_D = 50\text{A}$		390		
$T_{d(on)}$	Turn-on Delay Time	<b>Inductive switching @ 125°C</b> $V_{GS} = 15\text{V}$ $V_{Bus} = 800\text{V}$ $I_D = 50\text{A}$ $R_G = 0.8\Omega$		10		ns
$T_r$	Rise Time			10		
$T_{d(off)}$	Turn-off Delay Time			68		
$T_f$	Fall Time			36		
$E_{on}$	Turn-on Switching Energy	<b>Inductive switching @ 25°C</b> $V_{GS} = 15\text{V}, V_{Bus} = 800\text{V}$ $I_D = 50\text{A}, R_G = 0.8\Omega$		2.79		mJ
$E_{off}$	Turn-off Switching Energy			0.6		
$E_{on}$	Turn-on Switching Energy	<b>Inductive switching @ 125°C</b> $V_{GS} = 15\text{V}, V_{Bus} = 800\text{V}$ $I_D = 50\text{A}, R_G = 0.8\Omega$		5.6		mJ
$E_{off}$	Turn-off Switching Energy			0.81		

**Series diode ratings and characteristics**

Symbol	Characteristic	Test Conditions	Min	Typ	Max	Unit
$V_{RRM}$	Maximum Repetitive Reverse Voltage		200			V
$I_{RM}$	Maximum Reverse Leakage Current	$V_R = 200\text{V}$	$T_j = 25^\circ\text{C}$		350	$\mu\text{A}$
			$T_j = 125^\circ\text{C}$		600	
$I_F$	DC Forward Current			60		A
$V_F$	Diode Forward Voltage	$I_F = 60\text{A}$		1.1	1.15	V
		$I_F = 120\text{A}$		1.4		
		$I_F = 60\text{A}$	$T_j = 125^\circ\text{C}$		0.9	
$t_{rr}$	Reverse Recovery Time	$I_F = 60\text{A}$ $V_R = 133\text{V}$ $di/dt = 400\text{A}/\mu\text{s}$	$T_j = 25^\circ\text{C}$		24	ns
			$T_j = 125^\circ\text{C}$		48	
$Q_{rr}$	Reverse Recovery Charge	$I_F = 60\text{A}$ $V_R = 133\text{V}$ $di/dt = 400\text{A}/\mu\text{s}$	$T_j = 25^\circ\text{C}$		66	nC
			$T_j = 125^\circ\text{C}$		300	

**Parallel diode ratings and characteristics**

Symbol	Characteristic	Test Conditions	Min	Typ	Max	Unit
$V_{RRM}$	Maximum Repetitive Reverse Voltage		1200			V
$I_{RM}$	Maximum Reverse Leakage Current	$V_R = 1200V$	$T_j = 25^\circ C$		350	$\mu A$
			$T_j = 125^\circ C$		600	
$I_F$	DC Forward Current			120		A
$V_F$	Diode Forward Voltage	$I_F = 120A$		2	2.5	V
		$I_F = 240A$		2.3		
		$I_F = 120A$	$T_j = 125^\circ C$	1.8		
$t_{rr}$	Reverse Recovery Time	$I_F = 120A$ $V_R = 800V$ $di/dt = 400A/\mu s$	$T_j = 25^\circ C$	400		ns
			$T_j = 125^\circ C$	470		
$Q_{rr}$	Reverse Recovery Charge	$I_F = 120A$ $V_R = 800V$ $di/dt = 400A/\mu s$	$T_j = 25^\circ C$	2.4		$\mu C$
			$T_j = 125^\circ C$	8		

**Thermal and package characteristics**

Symbol	Characteristic	Min	Typ	Max	Unit	
$R_{thJC}$	Junction to Case Thermal Resistance	Transistor		0.1	$^\circ C/W$	
		Series diode		0.65		
		Parallel diode		0.46		
$V_{ISOL}$	RMS Isolation Voltage, any terminal to case $t = 1$ min, $I_{isol} < 1mA$ , 50/60Hz	2500			V	
$T_J$	Operating junction temperature range	-40		150	$^\circ C$	
$T_{STG}$	Storage Temperature Range	-40		125		
$T_C$	Operating Case Temperature	-40		100		
Torque	Mounting torque	To heatsink	M6	3	5	N.m
		For terminals	M5	2	3.5	
Wt	Package Weight			280	g	

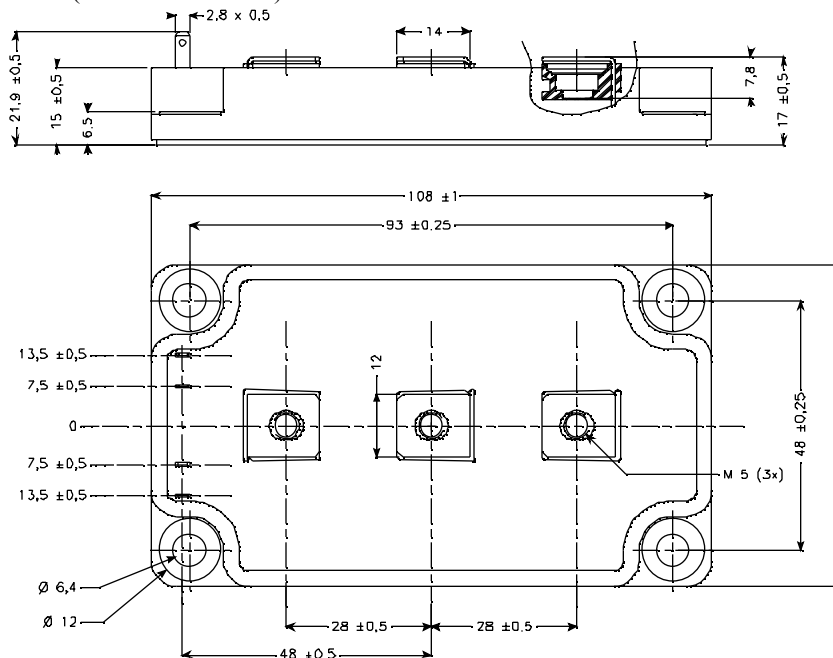
**SP6 Package outline (dimensions in mm)**

 See application note APT0601 - Mounting Instructions for SP6 Power Modules on [www.microsemi.com](http://www.microsemi.com)

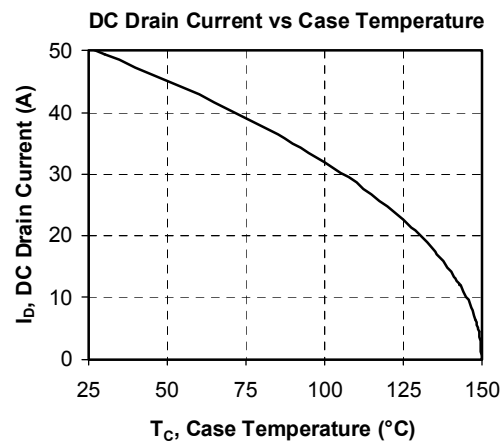
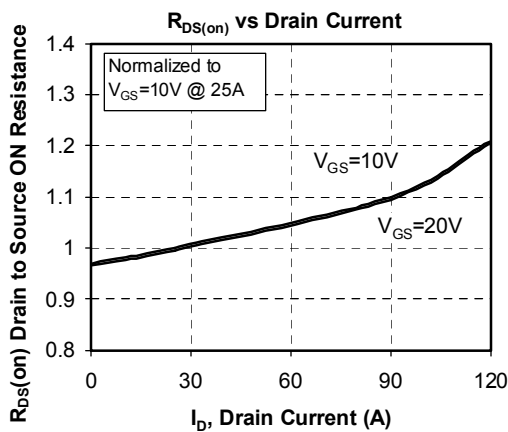
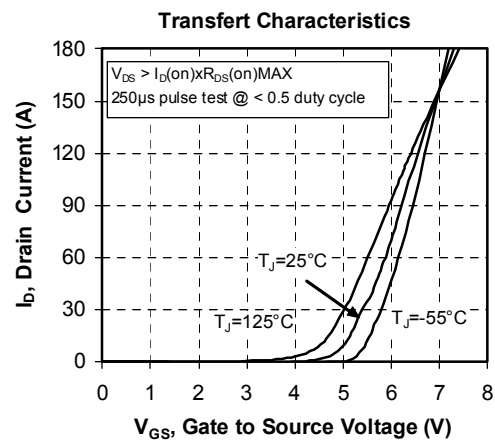
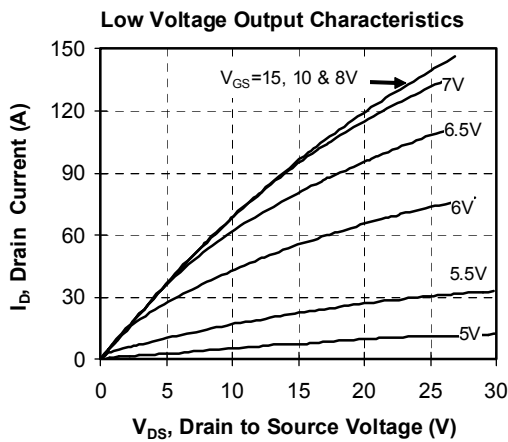
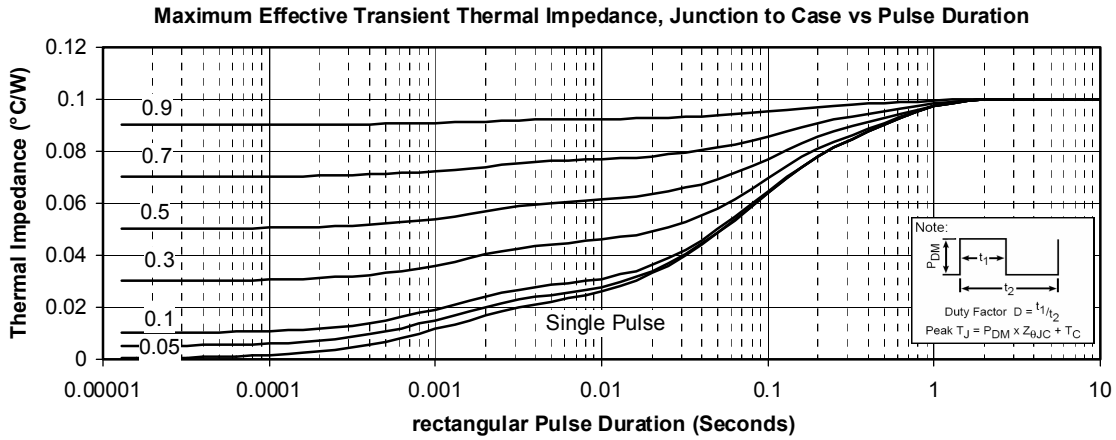
## Typical Performance Curve

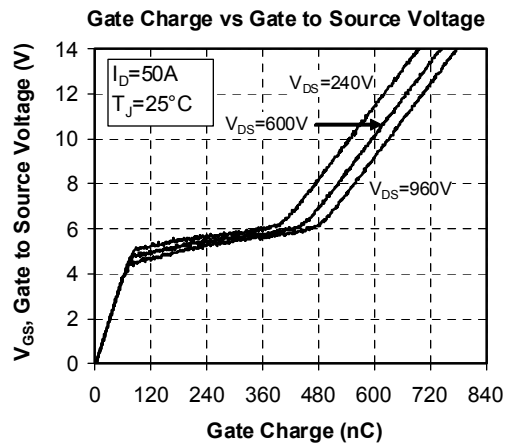
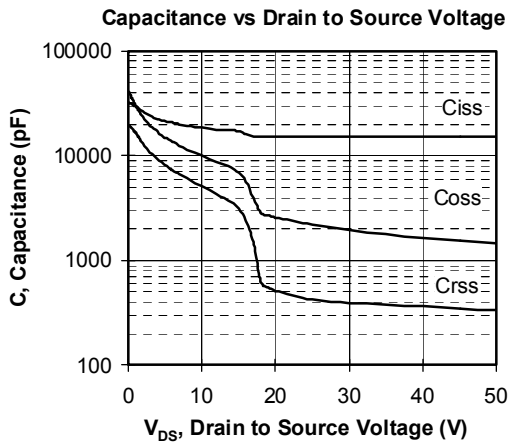
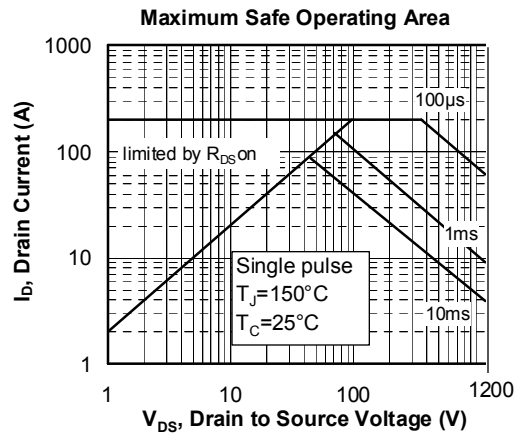
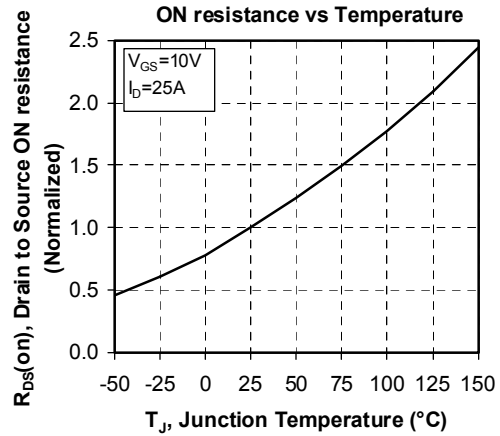

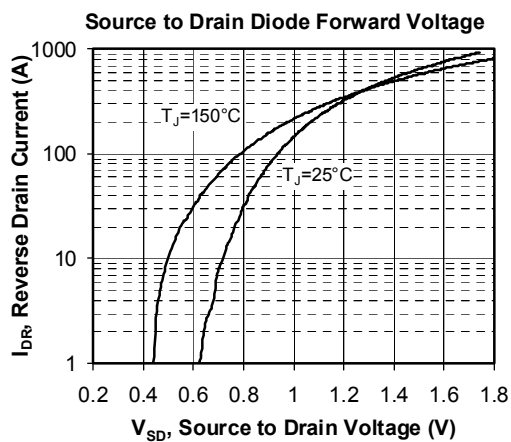
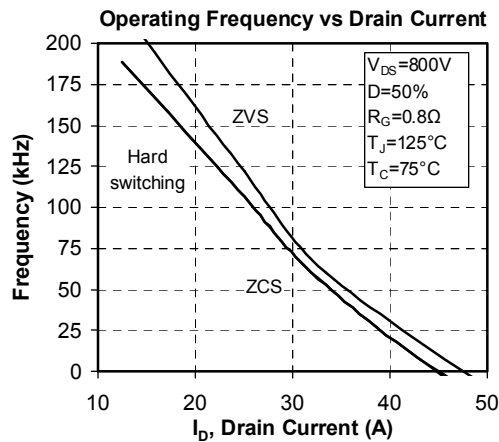
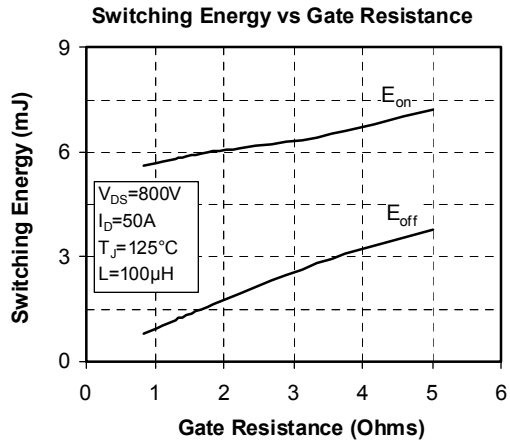
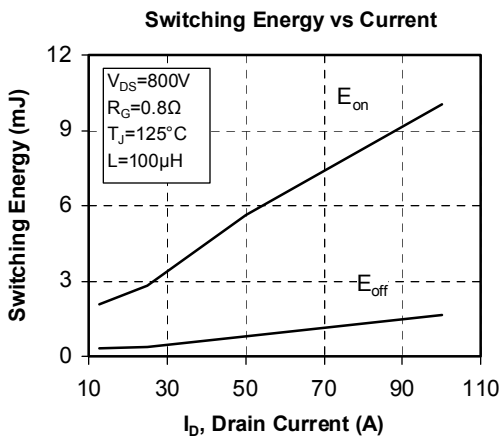
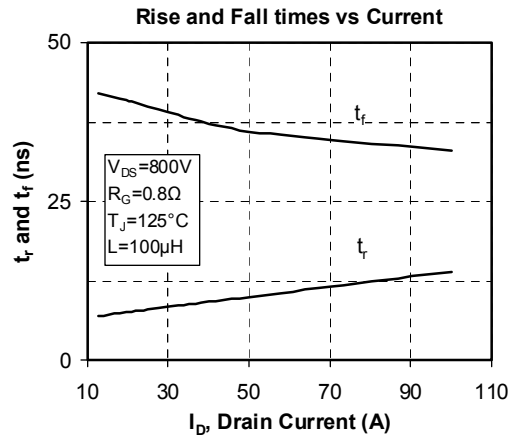
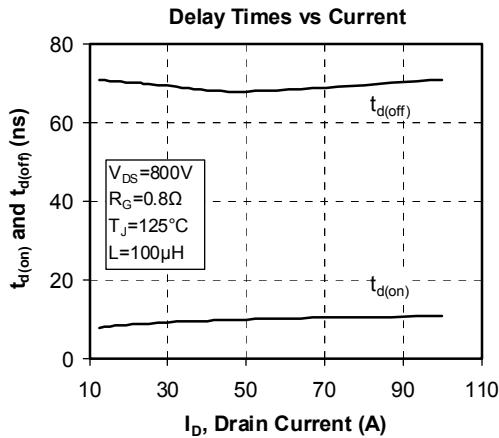



Microsemi reserves the right to change, without notice, the specifications and information contained herein

Microsemi's products are covered by one or more of U.S. patents 4,895,810 5,045,903 5,089,434 5,182,234 5,019,522 5,262,336 6,503,786 5,256,583 4,748,103 5,283,202 5,231,474 5,434,095 5,528,058 and foreign patents. U.S. and Foreign patents pending. All Rights Reserved.